

## Power Tillers

EL 122 / 162 / 282 / 402 R

EL 162-300 BIOMULCH



[www.kuhn.com](http://www.kuhn.com)



be strong, be **KUHN**







EL 122 162 282 402 R

# INTENSIVE TILLAGE FOR BETTER RESULTS IN HEAVY SOILS



Create a fine tilth seedbed also under very difficult conditions is the task, power tillers are designed to master. By enhancing the soil structure, crop germination and root development are supported, thus maximizing the yield. The large working widths make the EL 122, 162, 282 and 402 R models the preferred choice of larger arable or mixed farms, field vegetable farms and contractors.

## MULTI-PURPOSE TOOLS FOR MULTIPLE FIELDS OF OPERATION

Through their wide choice of working tools, rotors and rollers, as well as adjustment possibilities, you can adapt your power tiller easily to your specific needs.

## ROBUST AND RELIABLE

The robust design of KUHN high power tillers is an asset to tackle difficult conditions and very high horsepower tractors. A benefit: The machine holds its worth and provides a high resale value.

## KUHN's EL large-width power tillers in brief:



	Working width (m/ft)	Overall transport width (m/ft)	Max. authorized motor power at a PTO speed of 1,000 min <sup>-1</sup> (kW/hp)
<b>EL 122</b>	2.50 - 2.72 - 3.00 / 8'2" - 8'11" - 9'10"	2.77 - 2.99 - 3.25 / 9'1" - 9'10" - 10'8"	92/125
<b>EL 162</b>	2.50 - 3.00 / 8'2" - 9'10"	2.77 - 3.25 / 9'1" - 10'8"	121/165
<b>EL 162-300 BIOMULCH</b>	3.00 / 9'10"	3.25 / 10'8"	122/165
<b>EL 282</b>	3.00 - 4.00 - 4.50 / 9'10" - 13'1" - 14'9"	3.28 - 4.31 - 4.75 / 10'9" - 14'2" - 15'7"	201/270
<b>EL 402 R</b>	6.18 / 20'3"	3.00 / 9'10"	294 / 400



# MULTI-PURPOSE TOOLS FOR MULTI-PURPOSE USES

Driven tillage tools such as the KUHN power tillers are highly versatile and suitable for use in arable farming and field vegetable production. They work the soil intensively and perform in virtually all conditions, especially in heavy soil as well as in the presence of many stones. One pass is mostly sufficient to create a fine tilth seedbed. In combination with an integrated seed drill, seeding can be carried out at the same time.



## IMPROVE YOUR SOIL

Blades or tines work the soil and eject it against the hoods. This way soil is effectively loosened, crumbled and mixed with residues. KUHN power tillers are designed for intensive soil loosening and breaking up of clods. The work intensity depends on the rotor speed, the tool type as well as the ground speed. A general rule: The slower you work with the tiller and the quicker the rotor shaft turns, the finer the soil is crumbled. But it's important not to exaggerate this, as the soil's favorable crumble structure might be damaged.



## QUICK DECOMPOSITION OF RESIDUES

Rotor tillers mix superficial residues with the soil and loosen it to let air in. Therefore harvest residues, cover crops or the grass root system are rapidly decomposed.



## EL BIOMULCH POWER TILLER: BOOST YOUR LEVEL OF ORGANIC MATTER!

With the EL 162-300 BIOMULCH power tiller, increase your organic matter level and add value to your plant cover. Whether you practice minimum tillage or organic farming, the EL BIOMULCH tiller is an effective alternative to herbicides. Reducing your mechanization costs, it will quickly become the most versatile tillage machine on your farm. Synonymous with simplicity and performance, the EL 162-300 BIOMULCH is characterized by the presence of 4 front gauge wheels allowing shallow work up to 10 kph. Forget the smearing phenomena with the new 95-degree curved blades that provide shallow work over the entire surface and enjoy an optimal soil-residue mix with the hydraulic adjustment of the hood opening.



# TOOLS TO MATCH YOUR CULTIVATION METHOD

The unmatched versatility of KUHN power tillers comes with a wide choice of tools for different tillage applications, production systems or even crop residue incorporation.

## CULTIROTOR: EFFICIENT RESIDUE MIXING

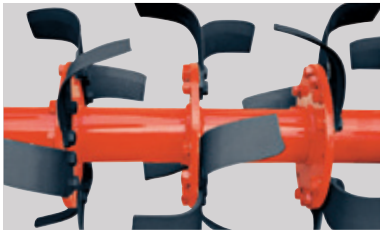

- Incorporation of cover crops and crop residues,
- Ploughing up of pastures and grassland,
- Multi-purpose applications for large farms.

The CULTIROTOR rotor is equipped with curved blades (in “L” or “C” version) efficient at mixing while producing a uniform finish. The six blades per flange also offer a good soil engagement and reduced power absorption. The blades are attached to the rotor by means of counter-flanges for increased resistance in hard and stony soil. The latter is standard on the EL 282 as well as HD rotors.

## CULTITILLER: STRAIGHT TINES FOR MAXIMUM EFFECT



- Secondary tillage applications,
- Min-till primary tillage,
- For stony conditions,
- Incorporation of short crop residues.

The leading tine position of the CULTITILLER rotor both lifts and cuts. Alternately left and right angled tines provide good soil levelling by moving soil side-to-side.

## QUICK-RELEASE SYSTEMS: BECAUSE TIME IS MONEY



**EXCLUSIVE**

### FAST-FIT ON CULTITILLER

This quick-release knife system is exclusively available from KUHN. Each knife is secured with a lynch pin. The sheath type fit holds them in place. In this way, all knives can be replaced in just a few minutes.

## CULTILOW: INCREASED TINE NUMBERS FOR MAXIMIZED CRUMBLING



- Secondary tillage of hard dry clay soils,
- Seedbed preparation in min-till applications,
- Fine seedbed preparation for spring-sown crops.

The high density and trailing tine position of the CULTILOW rotor maximizes the crumbling and reduction of soil clods while limiting the risks of clogging the rotor. The left and right angles of the tines provide good soil levelling by moving soil side-to-side.

### CULTILOW: EASY-FIT

On CULTILOW models, the EASY-FIT quick-release is the system of choice to make your life easier. Each blade can be removed and reinstalled by loosening and tightening only one attachment bolt.

## SIMPLIFIED ROTOR REMOVAL AND REPLACEMENT



For the EL 282 and EL 402 R models, the exclusive KUHN quick-change rotor system is available. It consists of rotor ends that are secured in “keystone” mounts. This provides:

- rapid exchange between the different rotors,
- safe blade replacement by separating the rotor from the chassis.

It takes just a few minutes to remove the five mounting screws and the rotor is on the ground!



# DESIGNED FOR LONG LIFE AND SIMPLE OPERATION

EL 122 and EL 162 power tillers are intended for tractors rated at up to 92 kW (125 hp) and 121 kW (165 hp), respectively. As with all KUHN implements intended for soil preparation, these power tillers feature a particularly sturdy design.

The one-piece frame, a two-speed gearbox, and the side drive by gearwheels meet the most stringent reliability requirements.

They are also designed for convenient operation, with extremely quick and easy to perform adjustments.





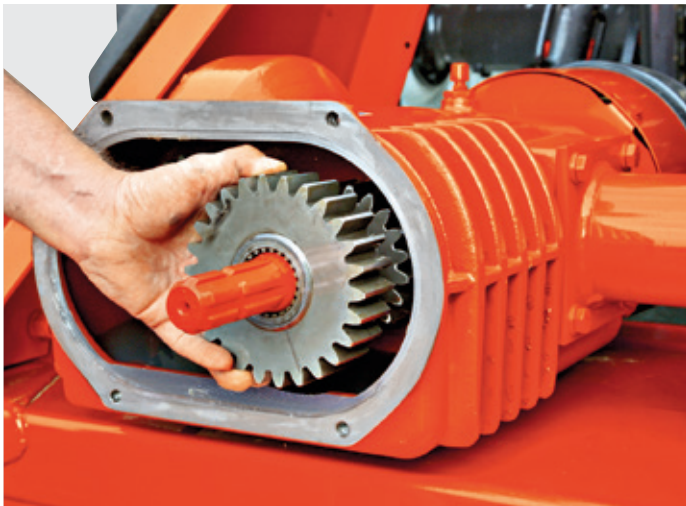

### DUPLEX GEARBOX: FLEXIBILITY FOR DIFFERENT SOIL CONDITIONS

Designed for heavy-duty applications, the gearbox is capable of handling powerful tractors. Thanks to the invertible gear sets, the rotor speed can be quickly adapted to obtain the required result: an adequate crumbling whatever the soil type is, light or hard. To offer a larger range of speeds, standard gearwheel sets as well as optional gearwheels are available. A rear PTO output available as standard enables power to be transmitted to other implements fitted to the tiller.

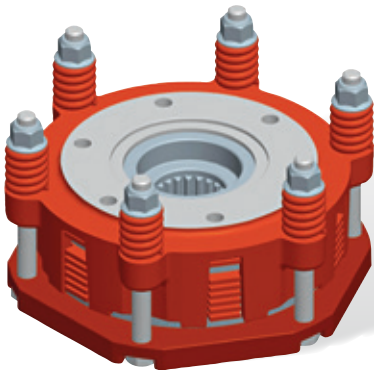

### A SOLID BOX FRAME

The heavy-gauge box section cross member acts as a one-piece frame. This offers improved rigidity even in the most arduous conditions. In stony conditions the machine's outer appearance is protected thanks to the double skin hood.

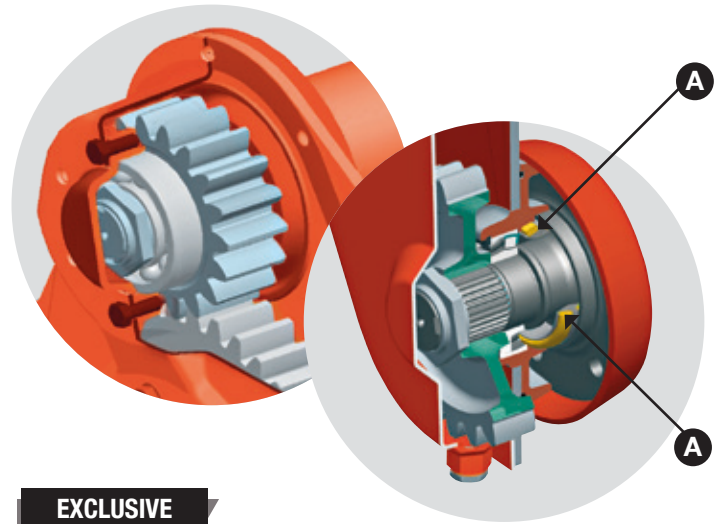

### EXCLUSIVE

### A FULLY RELIABLE ROTOR DRIVE

The power is transmitted to the large diameter rotor through an all gear drive. Gearwheels are made from case-hardened steel and run in an oil bath for an extremely long service life. The advantage: drive pinions are held in place **by bearings on both sides**, which provide improved support to the input pinion and maintain proper gear lash for excellent reliability. The rotor drive seal utilizes the most advanced sealing method available, a two-piece metallic face seal **(A)** for a superior performance in difficult service applications.

### EFFECTIVE DRIVE LINE PROTECTION

All models feature a torque limiting slip clutch with adjustable settings that protects driveline components from shock and excessive loads.

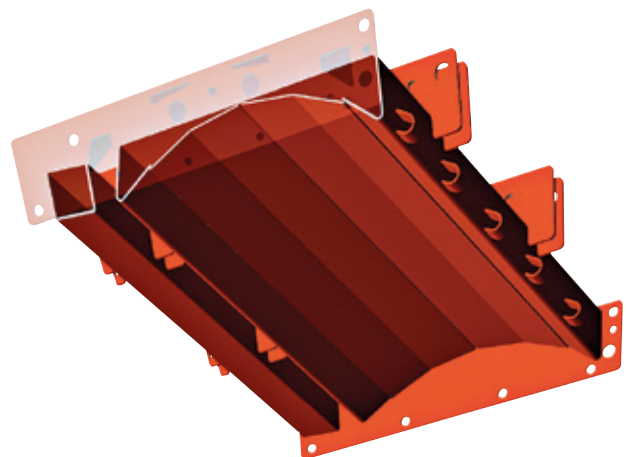



# BOOST YOUR LEVEL OF ORGANIC MATTER

The new EL BIOMULCH power tiller has been developed for incorporating fresh plants into the soil at a shallow depth and a working speed up to 10 kph. This is called biofumigation. This cultivation technique promotes the decomposition of the plant cover by increasing the organic matter level of the soil while preserving its biological activity. The EL BIOMULCH power tiller is highly versatile and can also be used for grassland destruction and stubble clearing.



Biofumigation of a plant cover obtained with a EL BIOMULCH power tiller

## Exploit your cover for organic matter!

By destroying your plant cover with the EL BIOMULCH power tiller you accelerate its decomposition, thus increasing the organic matter level of your soils. The mixture of soil and plant residues obtained by the shallow work of the first soil centimetres facilitates transformation of plant cover into organic matter, an excellent fertilizer for your soils. The rear hood's hydraulic adjustment system gives you optimal control of crumbling and mixing under all conditions.



### Numerous possibilities

Destroying plant cover and grassland, carrying out shallow stubble cultivation, incorporating organic fertiliser... With the new EL BIOMULCH power tiller you can carry out a multitude of operations. Thanks to its versatility, the EL BIOMULCH power tiller will quickly become the most versatile tillage machine on your farm. As an effective alternative to herbicides, the EL BIOMULCH excels in mechanical weeding. Working on a depth of between 3 and 6 cm, the blades cut the roots of weeds. This ensures weed control with fewer inputs. Try minimum tillage in organic farming systems.

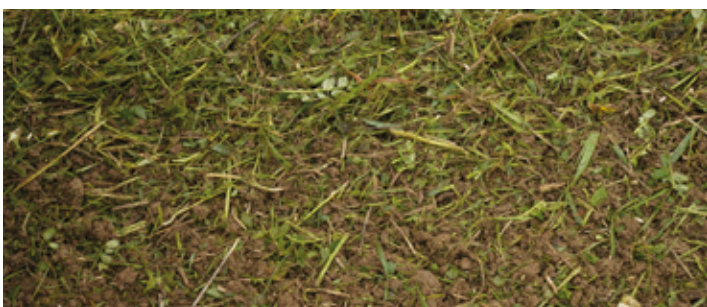

Destruction of plant cover



Shallow stubble clearing



# DESIGNED TO RESPECT YOUR SOILS

**Do you want to preserve soil life by improving its structure?**

**The EL BIOMULCH power tiller is for you!**

To ensure optimal control of the working depth, 4 gauge wheels provide optimal machine stability for homogeneous shallow work over the entire soil surface. New 95-degree curved blades have been developed to limit smearing phenomena. These new blades provide excellent quality of soil/plant residue mix.



## A perfect combination



To work in the densest plant cover, combine your EL BIOMULCH power tiller with the front-mounted BP 305 PRO shredder. This will give you the perfect combination to destroy the most developed plant cover.



### **Benefit from a tried-and-tested design**

Designed for heavy-duty applications, the DUPLEX gearbox equips the new EL BIOMULCH power tiller. Thanks to the invertible gear sets, the rotor speed can be quickly adapted to obtain an optimal result: adequate crumbling whether in heavy or light soil. For maximum protection, a friction slip clutch protects the driveline from shocks and excessive loads.



# UNMATCHED POWER TILLER DIMENSIONS!

Work in difficult conditions demands a great deal of a tillage tool. A Fine seedbed preparation in heavy soils, homogeneous incorporation of high residue quantities, outputs: That's what large arable and especially field vegetable farms will find when opting for a large-width KUHN EL power tiller. Because they are prepared for this.

The EL 282 power tillers from 3.00 to 4.50m working width as well as the new 6.18m wide EL 402 R – 600 meet their needs. They are designed for tractors of up to 270hp and 400hp, respectively.



ADAPTED FOR INTENSIVE USE UNDER DIFFICULT CONDITIONS  
WITH HIGH-POWER TRACTORS...

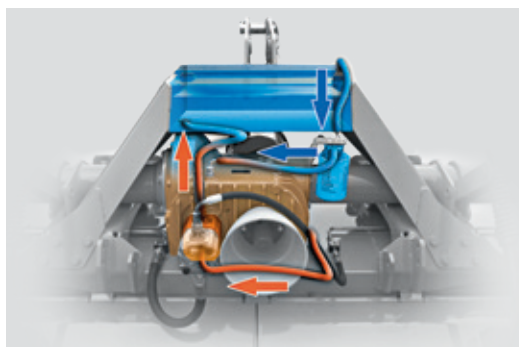
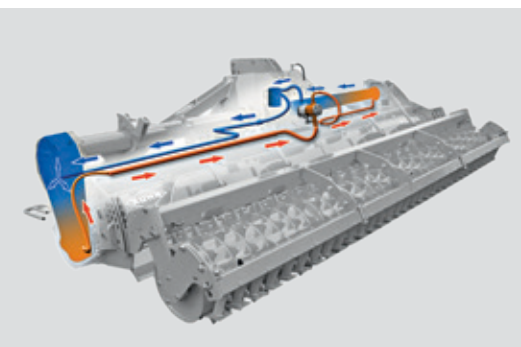

## A PERFORMING COOLING SYSTEM

The central and both lateral gearboxes of the EL 282 and EL 402 R-600 power tillers are equipped with integrated pumps for oil circulation that ensure both gearwheel lubrication and gearbox cooling. The oil tank has a large surface that allows efficient evacuation of the heat without requiring a delicate radiator and fan system that could easily become clogged. Moreover, the synthetic oil used works at higher temperatures than standard oils. Both oil systems are equipped with oil filters and are separated to prevent cross-contamination.

## DRIVE CHAIN IS PERFECTLY PROTECTED

Two cam cut-out clutches (one for each machine half) provide protection to the EL 402 R model in stony conditions.





### LARGE DIAMETER HD-ROTORS

The CULTIROTOR rotor with curved blades (550mm) - available on both models - is the ideal tool to prepare a perfectly fine seedbed and to mix high residue quantities. The EL 282 can also be equipped with CULTITILLER straight tines.

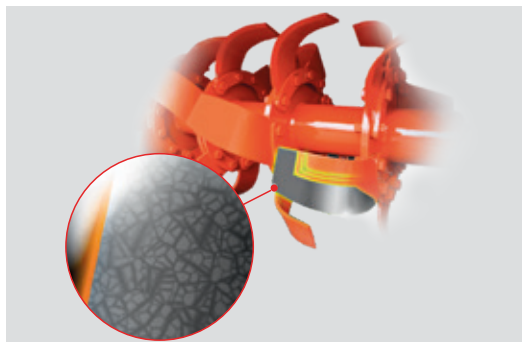

### DURAKUHN BLADES MADE TO LAST

Both power tiller models are supplied as standard with tungsten carbide-coated blades (10mm thick) for a long service life.



### KTS 20: THE ASSURANCE OF A RESPECTED SCHEDULE

In order to help the driver keep his schedule and peace of mind, the EL 402 R – 600 model is equipped as standard with the monitoring unit KTS 20. Installed in the cabin, it continuously monitors the temperature and rotation of the machine's three gearboxes as well as the cut-out clutch. If the sensors detect an error, the driver is immediately informed.



# AN UNRIVALLED DRIVE TRAIN

Apart from the cooling system, the EL 282 and EL 402 R power tiller provide a solid frame and drive train structure that make them the perfect solution for working in intensive conditions.

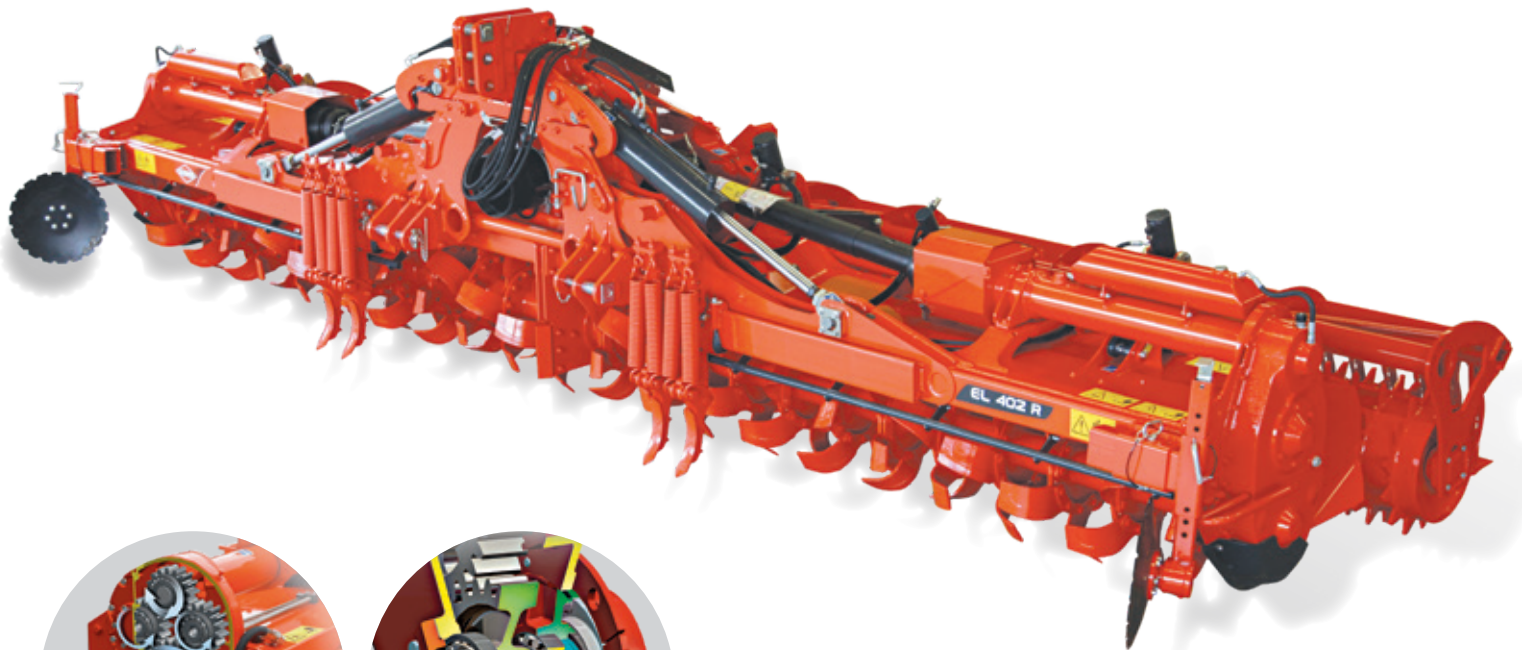

## EXCLUSIVE

### UNRIVALLED SIDE GEARBOXES

- All gearwheels in the gearbox are supported on both sides by tapered roller bearings.
- The large gear tooth profile used is unmatched in the industry.
- The double drive on EL 282 (design similar to the planetary gear train) ensures a smoother and more efficient drive than with two individual gearboxes: an exclusive KUHN feature!
- High performance sealing: The rotor drive flange is fitted with the best sealing system available, a metallic face seal for unequalled performance and long service life.

### DUPLEX CENTRAL GEARBOX

- The central gearbox of the EL 282 tillers has an interchangeable gearwheel drive. A wide range of rotor speeds is available to adapt to various situations.
- Central gearboxes are offset to the rear to increase PTO shaftlength while reducing PTO shaft angles. This facilitates the attachment and is useful for tractors with large-diameter wheels.

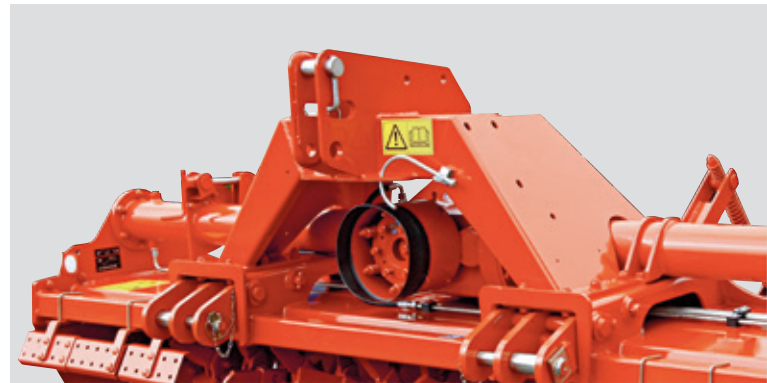

### HIGH-CAPACITY HEADSTOCK

Also the robust hitch frame is designed for intensive use. Side struts reinforce the framework on machines more than 3.00m wide. The linkage is designed for cat. 3 and 4 tractors (additionally 4N on EL 402 R-600). Moreover, both models are compatible as standard with North American style quick hitches in cat. 4 (also 3 on EL 282).





# PERFECTING SEEDBED PREPARATION

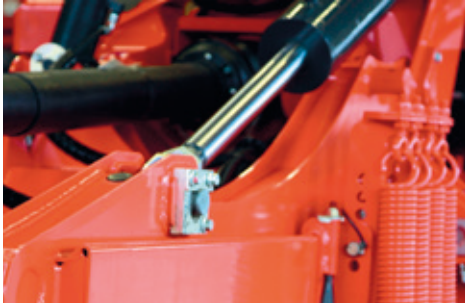

## A PERFECT FINISH

6.18m of working width with a roller 6.50m wide: This is the best solution to ensure a perfect soil surface levelling between each pass. In addition, there is an offset in the center of the machine between the junction of the 2 rotors and the 2 rollers. Thus the roller halves have different widths (3.00 vs. 3.50m), which allows avoiding unworked ridges between the two machine halves.



## A PERFECT ADAPTATION TO HETEROGENEOUS CONDITIONS

Soils may vary much within one plot. Simple, real-time adjustments are thus important to achieve superior work quality results in such changing conditions. On the EL 402 R power tiller both working depth and rear hoods can be adjusted hydraulically from the cabin, both using a master/slave system.

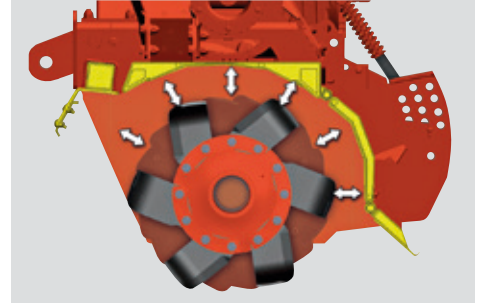

## A PERFECT DESIGN FOR LESS POWER CONSUMPTION

The significant clearance between the rotor and casing reduces power input and facilitates soil flow. Furthermore, in wet conditions, the machine has less tendency for power robbing soil build up to occur between the rotor and the body.

## BOTH HALVES MOVE

You have the possibility to work in rigid or floating position. In the latter configuration both halves can move up and down between +/- 2.5°.

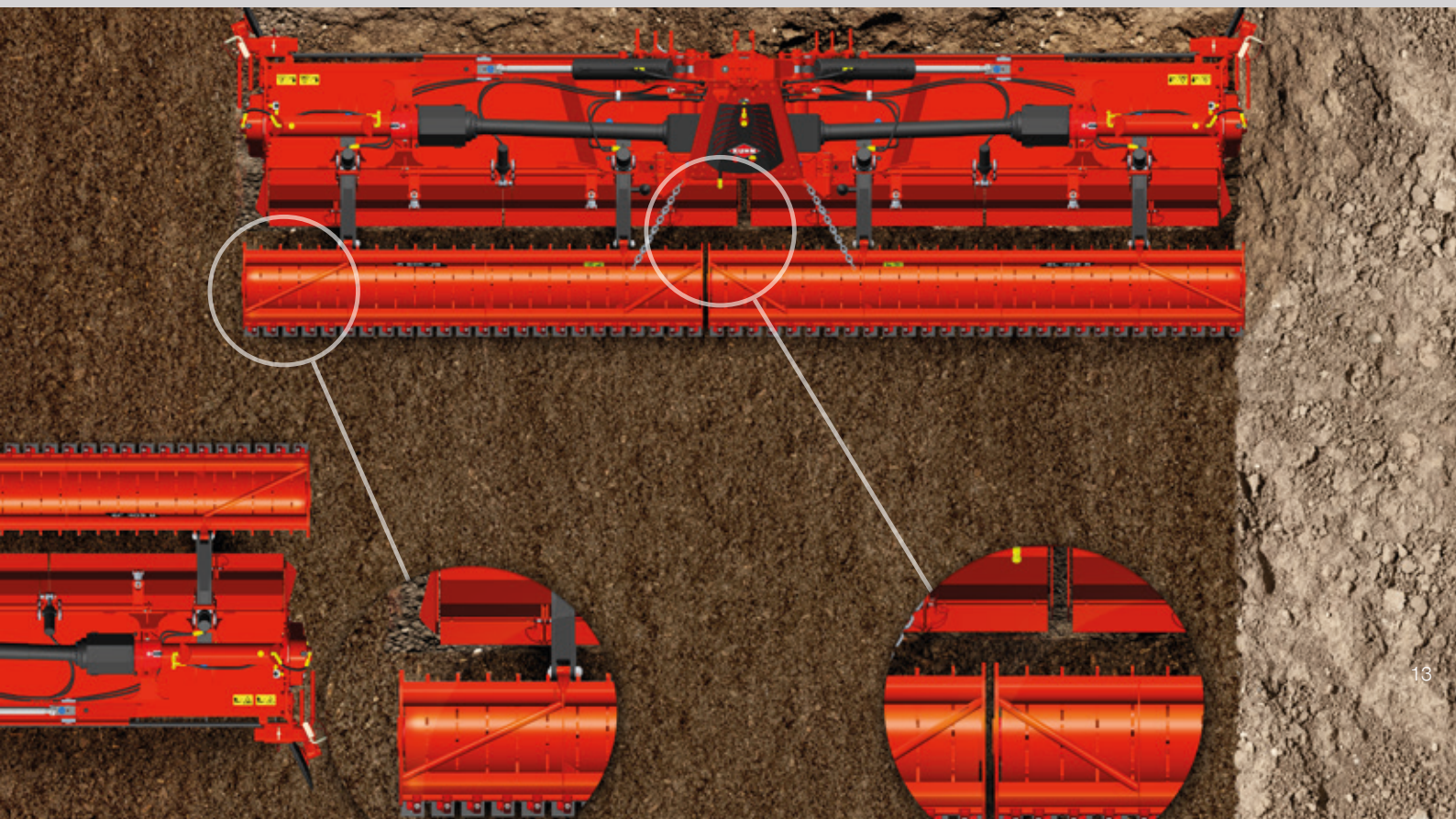



# MORE PRACTICAL FEATURES AND OPTIONS FOR YOUR BENEFIT



## A PIVOTING REAR HOOD FOR INCREASED ADJUSTMENT FLEXIBILITY

A wide range of rear hood adjustment options provides for:

- precise tuning of the soil crumbling and smoother operation.
- better adaptation to various working needs and conditions due to the two-piece hinged lower hood section.



The rear hood position and thus the soil crumbling intensity can be easily adjusted from the front of the tiller by means of a crank handle. This facilitates adjustments considerably with a rear-mounted roller and drill. The robust design of the hinges and hoods ensures a long service life. On EL 402 R-600, this adjustment can be done hydraulically from the cabin during work.



## SIDE SEPARATING DISCS FOR AN IDEAL LEVELLING

Optional side separating discs prevent furrowing and wrapping of the rotor ends with organic material. They are quickly adjustable in height and in spacing for an easy adaptation to any situation. They come in smooth version on all KUHN EL models with the exception of the notched discs on the new foldable EL 402 R-600 power tiller.

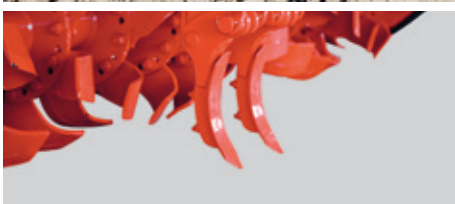

## WHEEL TRACK ERADICATORS

Optional wheel track eradicators are designed to break up and level the compacted soil behind the tractor wheels. They are adjustable both in depth and spacing. Depending on working conditions and the presence of stones in particular, a choice is available between traction bolt and spring reset safety release systems.

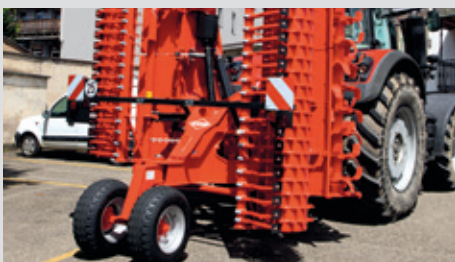

## EL 402 R-600: COMFORT ON THE ROAD

The EL 402 R-600 power tiller is folded hydraulically and locked in transport position. Pivoting twin wheels of large diameter on an optional transport frame make you move at ease on the road. No braking system is required while transport legislations can even be respected with mid-size tractors.



## REAR WHEELS

For shallow work (pasture reclamation, stubble clearing), the rear wheels can replace the roller. In transport position, they are pivoted to the inside to reduce the machine dimensions to a minimum.



## SKIDS OR FRONT WHEELS

These wheels are intended for work not requiring the surface to be entirely uniform. The front wheels are adjustable in spacing and will roll over firm soil without leaving tracks in the worked soil.



# PROFITABLE COMBINATIONS!



## TILL AND DRILL IN ONE

The EL power tillers can form a compact and performing combination with different integrated seed drills:

- the pneumatic VENTA series,
- the mechanical INTEGRA models.

## COMBINED TILLAGE

The 3.00m EL 122 and EL 162 models as well as the 3.00 and 4.00 m EL 282 models can be combined with a CULTISOIL soil loosener to break up deeper lying compacted soil layers in front of the machine (depth adjustable up to 35cm).



## DEPTH AND ROLLER ADJUSTMENT

On all models except EL 402 R - when fitted with a roller - depth adjustment is easily performed using pins inserted into a multi-hole plate. The roller is free to drop, maintaining maximum contact with the soil in any condition. This provides optimum tamping of the seedbed and helps level the cultivated surface.

On the EL 402 R power tiller on the other hand, you can adjust the working depth hydraulically from the tractor cabin.



# FOR UNIFORM CROP GERMINATION AND VIGOR

To better meet your needs and perform a quality soil preparation KUHN power tillers are offered with a choice of different depth-control options. Easy adjustment of the roller position provides fine-tuning capability to maximize the effects of soil preparation.

Note: All depth control options noted may not be available for all machines.

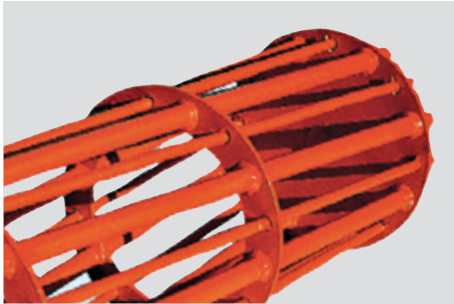

## CRUMBLER ROLLER

This roller of smaller diameter (390mm / 15.4") is suitable for use on dry, non-sticky soils without an integrated seed drill. The removable rods can be withdrawn, if required, to reduce clogging risks. Its maintenance requirements are minimal.

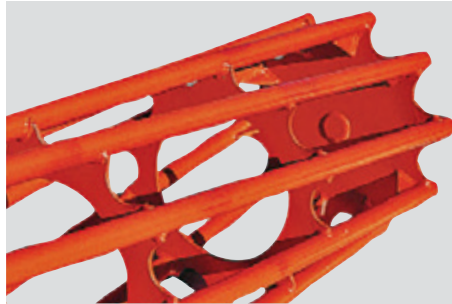

## MAXICRUMBLER ROLLER

The large diameter (520mm / 20") of this roller provides reduced rolling resistance and good depth control in dry, non-sticky soils without an integrated seed drill.

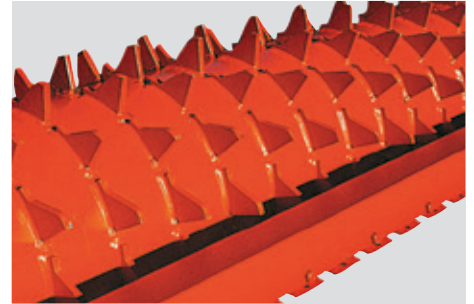

## PACKER 2 ROLLER

This roller of 515mm diameter (20.3") is suitable for a wide range of soil conditions and especially recommended for clay soils that tend to crack and harden while drying. They contribute to an optimum seedbed by uniformly firming the soil while leaving loose soil on top. Suitable for use with lighter integrated drills.

## KUHN SERVICES\* Maximize the use and productivity of your KUHN equipment

\*Certain services and equipment are not available in all countries.

### KUHN sos order

#### EXPRESS SPARE PARTS SERVICE 24/7

You urgently need spare parts? With KUHN sos order benefit from express delivery seven days a week, 365 days a year. Thus, you can minimize machine downtime considerably and increase your work output.

### KUHN protect +

#### THE CHOICE OF PROFESSIONALS!

Benefit from 36 months in complete serenity because of KUHN's protect+ warranty. You can concentrate exclusively on your work and the performance of your machine. Because this is what you expect, when investing in high-tech machinery.

### KUHN i tech

#### FOR EVER QUICKER REPAIRS!

An unexpected technical problem always occurs at the wrong time. Your KUHN dealer can support you quickly and efficiently thanks to KUHN i tech. With this 24/7 online service, a quick and exact diagnosis is possible.

### KUHN finance

#### INVEST RATIONALLY!

New machine necessary, financing unsure? Modernize your equipment and develop your farm with KUHN finance, in total safety and according to your needs and demands. We offer custom-made finance solutions, adapted to your requirements.





Source: sprisi/pixelio.de

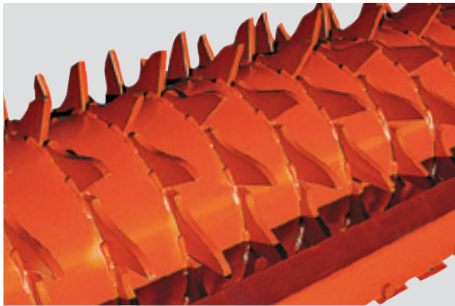

### MAXIPACKER ROLLER

Its large diameter (535mm / 21") reduces the rolling resistance and increases floatation. It can ideally be combined with heavier drills and planters. Coated scrapers are supplied as standard to maximize the service life, reduce adjustment and improve cleaning of the roller in sticky soils.



### PACKLINER ROLLER

A very large diameter of 592mm (23") cares for very good rotation and loadbearing capacity in all soil types, but particularly in wet conditions. It leaves the surface well tamped. Coated scraper plates are also fitted as standard to reduce maintenance.



### STEELLINER ROLLER

This roller tamps the future seed furrow and has a very good rotation and carrying capacity thanks to its large outer diameter of 550mm (21.7"). It performs through its increased crumbling capacity on dry and hard soils, to complete the action of the tiller tools by crushing remaining large clods. A good soil structure even in difficult and wet sowing conditions is the result.



be strong, be **KUHN**

## KUHN PARTS

Designed and manufactured to rival time



KUHN foundries and forge as well as a high-level manufacturing process allow the production of spare parts to defy time. You can truly rely on our know-how and our genuine parts. Farmers benefit from our client support and logistics services via any KUHN PARTS warehouse, which provide quick and reliable repair solutions in cooperation with your nearest authorized KUHN dealer.











## Technical specifications







		EL 122/250	EL 122/280	EL 122/300	EL 162/250
Working width (m/ft)		2.50 / 8'2"	2.72 / 8'11"	3.00 / 9'10"	2.50 / 8'2"
Overall width (m/ft)		2.77 / 9'1"	2.99 / 9'10"	3.25 / 10'8"	2.77 / 9'1"
Attachment		3-point, cat.2 (compatible quick hitch cat. 2 and 3)			
Working depth adjustment		by front wheels			
Side drive					
Max. authorized motor power at a PTO speed of 1,000 min <sup>-1</sup> (kW/hp)		92 / 125			
PTO safety					
PTO speed (min <sup>-1</sup> )		540 / 750 / 1,000			
Rear PTO shaft					
Gearbox(es)		DUPLEX with 2 sets of gearwheels			
Two-piece rear hood					
Rear hood adjustment		front crank handle			
Side separating discs		◇ (smooth)			
Working depth, min-max (cm/in)		8 - 23 / 3.1" - 9.1"			8 - 25 /
Rotor diameter (mm/in)	CULTIROTOR	525 / 20.7"			550 /
	CULTITILLER	520 / 20.5"			57 0 /
	CULTILOW	550 / 21.7"			57 0 /
Number of blades or tines	C-/L-blades (CULTIROTOR)	60	66	72	60
	trailing tines (CULTITILLER)	56	60	66	56
	leading tines (CULTILOW)	84	88	100	84
Weight (kg/lbs) CULTIROTOR - CULTITILLER - CULTILOW	with skids	955-970-1,095 / 2,105-2,140-2,415	995-1,007-1,155 / 2,195-2,220-2,545	1,045*-1,055-1,215 / 2,305-2,325-2,680	1,095-1,100-1,167 / 2,415-2,425-2,575
	with front wheels	980-995-1,120 / 2,160-2,195-2,470	1,020-1,032-1,180 / 2,250-2,275-2,600	1,070*-1,080-1,240 / 2,360-2,380-2,735	1,120-1,125-1,192 / 2,470-2,480-2,630
	with MAXICRUMBLER roller	1,080-1,095-1,220 / 2,380-2,414-2,690	1,180-1,192-1,340 / 2,600-2,630-2,955	1,195*-1,205-1,365 / 2,635-2,655-3,010	1,220-1,225-1,292 / 2,690-2,700-2,850
	with MAXIPACKER roller	1,320-1,335-1,460 / 2,910-2,945-3,220	-	1,470*-1,480-1,640 / 3,240-3,265-3,615	1,460-1,465-1,532 / 3,220-3,230-3,380

◆ standard ◇ option - not available \*CULTIROTOR HD: add 60 kg of weight.

### Rotational speeds (min<sup>-1</sup>) - EL 122

PTO speed (min <sup>-1</sup> )	1st gearwheel set (22/26 teeth) as standard		2nd gearwheel set (28/20 teeth) as standard		Optional gearwheel set (30/18 teeth)		Optional gearwheel set (24/24 teeth)
	26/22 	22/26 	28/20 	20/28 	30/18 	18/30 	24/24 
540	-	195	-	231	-	275	165
750	194	271	264	321	-	382	229
1,000	258	361	218	-	183	-	305

### Rotational speeds (min<sup>-1</sup>) - EL 162

PTO speed (min <sup>-1</sup> )	1st gearwheel set (23/30 teeth) as standard		2nd gearwheel set (28/25 teeth) as standard		Optional gearwheel set (33/20 teeth)		Optional gearwheel set (18/35 teeth)
	30/33 	23/30 	28/25 	25/28 	33/20 	20/33 	18/35 
540	-	186	-	-	-	235	277
750	-	258	177	222	-	327	385
1,000	202	344	236	296	160	-	-



**POWER TILLERS FOR ARABLE FARMING**

EL 162/300	EL162-300 BIOMULCH	EL 282/300	EL 282/400	EL 282/450	EL 402 R - 600
3.00 / 9'10"			4.00 / 13'1"	4.50 / 14'9"	6.18 / 20'3"
3.25 / 10'8"		3.28 / 10'9"	4.31 / 14'2"	4.75 / 15'7"	6.54 / 21'5" (in work position) 3.00 / 9'10" (in transport position)
3-point, cat. 2		3-point, cat. 3 or 4			3 point - cat. 3, 4, 4N (compatible for quick hitch cat. 4)
		by front wheels, rollers or rear wheels			hydraulically
◆ (by gearwheels running in permanent oil bath)					
1 21 / 165		201 / 270			294 / 400
friction slip clutch					cam-type cut out clutch
		750 / 1,000			1,000
◆					
		DUPLEX with 1 set of gearwheels			1 central gearbox + 2 side gearboxes
◆					
hydraulically and continuously (standard)		front crank handle			hydraulically and continuously
-					◇ (notched)
3.1" - 9.8"	3 - 6 / 1.2" - 2.3"	8 - 26 / 3.1" - 10.2"			0 - 26 / 0 - 10.2"
21.7" (C-blades) - 590 / 23.2" (L-blades)		617 / 24.3" (C-blades) - 585 / 23" (L-blades)			550 / 21.7"
22.4"	-	600 / 23.6"			-
22.4"	-	-			-
72		96	108	144 (DURAKUHN - 10mm)	
66	-	60	80	90	-
100	-	92	120	-	-
1,200-1,210-1,305 / 2,645-2,670-2,880		-			
1,225-1,235-1,330 / 2,700-2,725-2,930	1,225-2,700	-			
1,350-1,360-1,455 / 2,975-3,000-3,210	-	1,870-1,825 / 4,125-4,025	2,210-2,145 / 4,870-4,730	2,400-2,335 / 5,290-5,150	3,955 / 8,720
1,625-1,635-1,730 / 3,580-3,605-3,815	-	2,095-2,050 / 4,620-4,520	2,565-2,500 / 5,655-5,510	2,790-2,725 / 6,150-6,010	4,490 / 9,900

Rotational speeds (min <sup>-1</sup> ) - EL 282						
PTO speed (min <sup>-1</sup> )	1st gearwheel set (24/26 teeth) as standard		2nd gearwheel set (22/28 teeth) as optional equipment		Optional gearwheel set (21/29 teeth)	
	26/24	24/26	28/22	22/28	29/21	21/29
750						
750	-	214	-	252	-	274
1,000	244	287	208	337	192	366

**Optional equipment EL 122/162:** rotor counter flanges for CULTIROTOR models - standard or high capacity hydraulic rear hitch – rear rollers - front wheels (Ø 355 mm, l. 195 mm) - reinforced track eradicators with traction bolt or spring safety – side separating discs – road lights and signalling equipment – extra set of gearwheels – rear wheel kit - semi-automatic linkage - forged points for the CULTITILLER rotors.

**Optional equipment EL 282:** high capacity seed drill hitch - rear rollers, front wheels (steel - 355 mm x 195 mm (14" x 7.7") – reinforced track eradicators with traction bolt or spring safety – side separating discs – road lights and signalling equipment – extra set of gearwheels – rear wheel kit.

**Optional equipment EL 402 R - 600:** side separating discs - wheel track eradicators - transport frame.



# KUHN GUIDE: EVERYTHING YOU NEED TO KNOW ON PLANT COVER

**To improve economic and environmental performances of farms, new and innovative techniques are needed.**

But it is not so simple because managing intercropping periods is always a compromise between several objectives.

Discover in this guide the keys to succeeding in your intermediate crops!



**Check out KUHN's extensive offer of seed drills**



1. mounted mechanical 2. integrated mechanical 3. with front hopper 4. integrated pneumatic 5. trailed pneumatic 6. mounted for min-till 7. trailed for min-till 8. precision seed drills

**For more information about your nearest KUHN dealer, visit our website [www.kuhn.com](http://www.kuhn.com)**



Visit us on our YouTube channels.



[www.kuhn.com](http://www.kuhn.com)

Your KUHN dealer

#### **KUHN SAS**

4 Impasse des Fabriques - BP 50060  
F-67706 Saverne CEDEX - FRANCE

#### **KUHN NORTH AMERICA, INC.**

1501 West Seventh Avenue - P.O BOX 167 - Brodhead, WI 53520 - USA

#### **KUHN FARM MACHINERY PTY. LTD**

313-325 Foleys road - Deer Park, 3023 Victoria AUSTRALIA

#### **KUHN FARM MACHINERY (U.K.) LTD**

Stafford Park 7 - GB TELFORD/ SHROPS TF3 3BQ

Information given in this document is only for information purposes and is non-contractual. Our machines are in compliance with regulations in force in the country of delivery. In our literature, and for improved illustration of certain details, some safety devices may not be in operating position. When operating these machines, these devices must be in position in accordance with the requirements indicated in the operator's manuals and assembly manuals. Respect the tractor gross vehicle weight rating, its lift capacity and maximum load per axle and tyres. The tractor front axle load must always comply with the regulations of the country of delivery (In Europe, it must reach minimum 20 % of the tractor net weight). We reserve the right to change any designs, specifications or materials listed without further notice. Machines and equipment in this document can be covered by at least one patent and/ or registered design. Trademarks cited in this document may be registered in one or several countries.

Also find KUHN on

